

Mounts

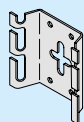

S45 Mounting Bracket
316 St. Steel 570598 655530 2

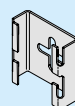

S45M Mounting Bracket
316 St. Steel 570598 655531 9



S14 Mount
Polypropylene
570598 199610 0



S14M Mount
Polypropylene
570598 199611 7



S15 Plastic Cap
ø0.16" / ø4 mm - black
Polypropylene
570598 199621 6

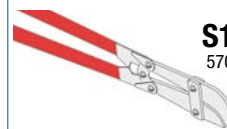

S19 Bolt Cutter
570598 210002 5



S330 Mount
Polypropylene
570598 699330 2

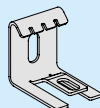

S147 Mounting Bracket
304 St. Steel
570598 750532 0



S16 Plastic Cap
ø0.20" / ø5 mm - black
Polypropylene
570598 199622 3

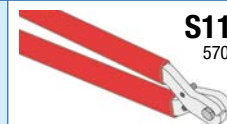

S119 Bolt Cutter
570598 210003 2

Splice Plates S40B and S41B Applications

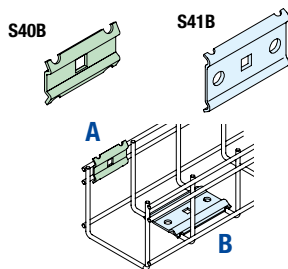

	S115	S116	S125	S126	S127	S128	S129	S130	S131	S132	S133
S40B	-	-	F	D	D	-	-	-	-	-	-
S41B	-	-	-	F	F	H	H	H	H	H	H

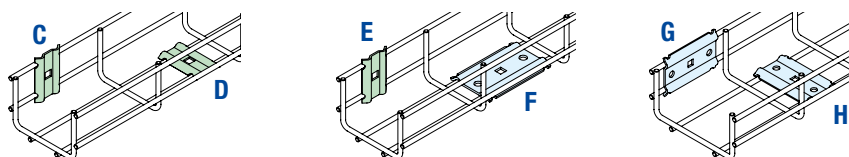

Wall Mounts with Wide Wall Clearance

Used with Trays S126 - S133

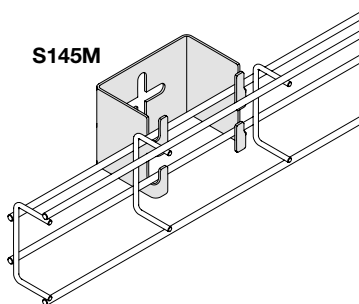

S145M

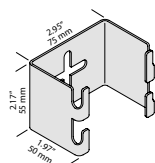

S145M Wall Mount
304 St. Steel 570598 755531 8

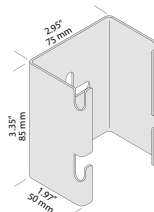

S145 Wall Mount
304 St. Steel 570598 755530 1

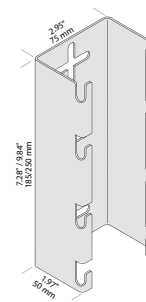

S180 Wall Mount
304 St. Steel 570598 765180 5

S181 Wall Mount
304 St. Steel 570598 765181 2

Disposition

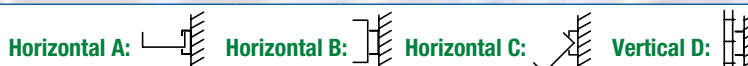

	S115	S116	S125	S126	S127	S128	S129	S130	S131	S132	S133
Splice Parts											
S90	•	•	•	•	•	•	•	•	•	•	•
S87	•	•	•	•	•	•	•	•	•	•	•
S40B			•	•	•	•	•	•	•	•	•
S42	•	•	•	•	•	•	•	•	•	•	•
S43	•	•	•	•	•	•	•	•	•	•	•
S41B				•	•	•	•	•	•	•	•
Mount											
S45				B,C,D	B,C,D	B,C,D	B,D	B,D	B,D	B,D	B,D
S45M				B,C,D	B,C,D	B,C,D					
S14					B,D	B,D					
S14M			B,D	B,D							
S15			•	•	•	•					
S16							•	•	•	•	•
S330							B,D	B,D	B,D	B,D	B,D
S145M				B	B						
S145						B	B	B			
S147				A	A	A	A	A			
S180									B	B	
S181											B