









# Siltec Open Cable Trays

Tray Overview		*0.20 inches Ø Wire Material	
<b>S25</b>		<b>1.0" x 1.0" x 118"</b> - $\phi 0.15"$ 25 x 25 x 3000 mm - $\phi 4$ mm	316 St. Steel 570598 620105 6 304 St. Steel 570598 720105 5
<b>S26</b>		<b>2.0" x 2.0" x 118"</b> - $\phi 0.15"$ 50 x 50 x 3000 mm - $\phi 4$ mm	316 St. Steel 570598 620106 3 304 St. Steel 570598 720106 2
<b>S30M</b>		<b>1.4" x 1.6" x 118"</b> - $\phi 0.15"$ 35 x 40 x 3000 mm - $\phi 4$ mm	304 St. Steel 570598 720117 8
<b>S30</b>		<b>1.8" x 2.4" x 118"</b> - $\phi 0.15"$ 45 x 60 x 3000 mm - $\phi 4$ mm	316 St. Steel 570598 620118 6 304 St. Steel 570598 720118 5
<b>S30*</b>		<b>1.8" x 2.4" x 118"</b> - * $\phi 0.20"$ 45 x 60 x 3000 mm - * $\phi 5$ mm	316 St. Steel 570598 620119 3 304 St. Steel 570598 720119 2
<b>S35</b>		<b>2.2" x 4.0" x 118"</b> - $\phi 0.15"$ 55 x 100 x 3000 mm - $\phi 4$ mm	304 St. Steel 570598 720120 8
<b>S35*</b>		<b>2.2" x 4.0" x 118"</b> - * $\phi 0.20"$ 55 x 100 x 3000 mm - * $\phi 5$ mm	316 St. Steel 570598 640120 3 304 St. Steel 570598 740120 2
<b>S35W</b>		<b>2.2" x 6.0" x 118"</b> - $\phi 0.20"$ 55 x 150 x 3000 mm - $\phi 5$ mm	316 St. Steel 570598 620120 9 304 St. Steel 570598 720121 5





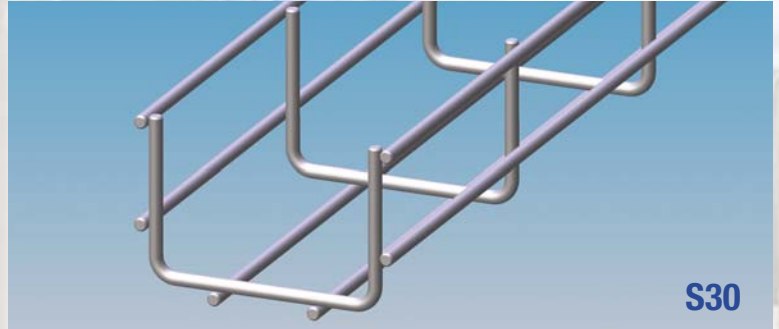
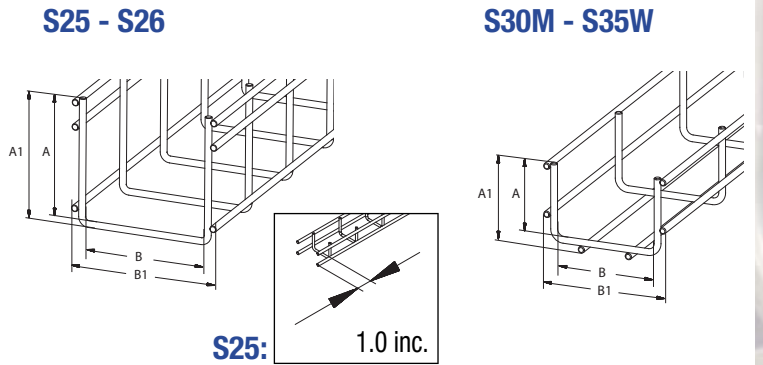





## Tray Dimensions

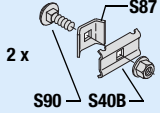

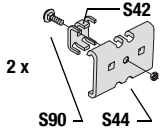
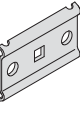
All dimensions in inches!

	S25	S26	S30M	S30	S30*	S35	S35*	S35W
<b>A:</b>	0.95	1.97	1.42	1.77	1.77	2.01	2.01	2.01
<b>A1:</b>	1.06	2.13	1.73	2.09	2.17	2.40	2.40	2.40
<b>B:</b>	1.10	1.97	1.57	2.44	2.44	3.94	3.94	5.87
<b>B1:</b>	1.65	2.60	2.05	3.07	3.23	4.53	4.69	6.65

## Splice Parts / Mounts Use Examples with These Parts are Shown on This Page, and Pgs 12, 14 & 15

 <p><b>S40 Splice Kit</b> 316 St. Steel 570598 650501 7</p>	 <p><b>S40B Splice Plate</b> 316 St. Steel 570598 650512 3</p>	 <p><b>S42 Splice Bracket</b> 316 St. Steel 570598 650508 6</p>
 <p><b>S150 Splice Kit</b> 316 St. Steel 570598 650150 7</p>	 <p><b>S41B Splice Plate</b> 316 St. Steel 570598 650513 0 304 St. Steel 570598 750513 7</p>	 <p><b>S87 Splice Bracket</b> 316 St. Steel 570598 680596 4</p>
 <p><b>S14/S330 Mount</b> Polyprop.</p> <p><b>S14</b>, <math>\phi 0.15"</math> / <math>\phi 4</math> mm 570598 199610 0 <b>S330</b>, <math>\phi 0.20"</math> / <math>\phi 5</math> mm 570598 699330 2</p>	 <p><b>S14M Mount</b> Polyprop. 570598 199611 7</p>	 <p><b>S90 Bolt Kit</b> 316 St. Steel 570598 685596 9</p>
 <p><b>S90H J-Bolt Kit</b> 304 St. Steel 570598 785598 2</p>		

## Splice Plates S40B & S41B Applications

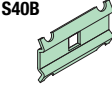
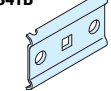
	S25	S26	S30M	S30	S35	S35W
<b>S40B</b>	A, F	E	C, F	C, D	C	C
<b>S41B</b>	-	A, B	G	G, F	G, H	G, H

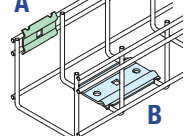

**A**

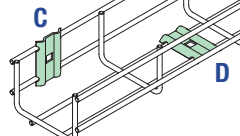

**C**

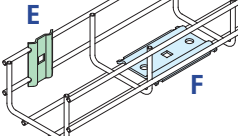

**E**

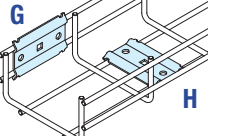





**G**









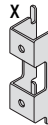
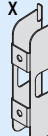
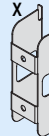

# Mounting Brackets

More Assembly Parts, Mounts and Accessories on Pgs 10-11

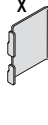

## Weld-Mount

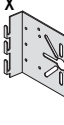

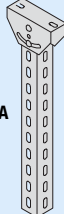

 <p><b>S51</b> Weld Bracket 316 St. Steel 570598 655545 6</p>	 <p><b>S52</b> Weld Bracket 316 St. Steel 570598 655546 3</p>	 <p><b>S60</b> Weld Bracket 316 St. Steel 570598 655554 8</p>	 <p><b>S63</b> Weld Bracket 316 St. Steel 570598 655557 9</p>
--	--	--	--

## Screw-Mount

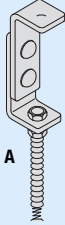
 <p><b>S46</b> Mounting Brackets X: 0.79" / 20 mm 316 St. Steel 570598 655540 1</p>	 <p><b>S47</b> Mounting Brackets X: 0.79" / 20 mm 316 St. Steel 570598 655541 8</p>	 <p><b>S56</b> Mounting Brackets X: 0.59" / 15 mm 316 St. Steel 570598 655550 0</p>	 <p><b>S57</b> Mounting Brackets X: 0.79" / 20 mm 316 St. Steel 570598 655551 7</p>
 <p><b>S153</b> Mounting Brackets X: 1.97" / 50 mm 316 St. Steel 570598 650153 8</p>	 <p><b>S154</b> Mounting Brackets X: 1.97" / 50 mm 316 St. Steel 570598 650154 5</p>	 <p><b>S155</b> Mounting Brackets X: 1.97" / 50 mm 316 St. Steel 570598 650155 2</p>	
 <p><b>S145</b> Mounting Brackets X: 1.97" / 50 mm 304 St. Steel 570598 755530 1</p>	 <p><b>S145M</b> Mounting Brackets X: 1.97" / 50 mm 304 St. Steel 570598 755531 8</p>	 <p><b>S146</b> Mounting Brackets X: 1.97" / 50 mm 304 St. Steel 570598 750146 9</p>	
 <p><b>S45M</b> Mounting Brackets X: 0.79" / 50 mm 316 St. Steel 570598 655531 9</p>	 <p><b>S45</b> Mounting Brackets X: 0.79" / 50 mm 316 St. Steel 570598 655530 2</p>	 <p><b>S80</b> Mounting Brackets A: 5.12" B: 4.72" X: 0.79" A: 130 mm B: 120 mm X: 20 mm 316 St. Steel 570598 665591 0</p>	
 <p><b>S81</b> Mounting Brackets A: 7.87" B: 4.72" X: 0.79" A: 200 mm B: 120 mm X: 20 mm 316 St. Steel 570598 665592 7</p>	 <p><b>S65</b> Angle Bracket A: 5.71" / 145 mm 316 St. Steel 570598 665560 6</p>	 <p><b>S66</b> Angle Bracket A: 9.65" / 245 mm 316 St. Steel 570598 665561 3</p>	

## Ceiling Mounts

 <p><b>S71</b> Ceiling Hanger <b>S71/500:</b> A: 16.69" / 500 mm 316 St. Steel 570598 665571 2 <b>S71/250:</b> A: 9.84" / 250 mm 316 St. Steel 570598 665573 6 <b>S71/750:</b> A: 29.53" / 750 mm 316 St. Steel 570598 665574 3</p>
 <p><b>S72</b> Clg Hanger Extension A: 39.37" / 1000 mm 316 St. Steel 570598 665575 0</p>
 <p><b>S73</b> Ceiling Hanger A: 39.37" / 1000 mm 316 St. Steel 570598 665572 9</p>

	Horizontal A: 	Horizontal B: 	Horizontal C: 	Vertical D: 				
Disposition	S25	S26	S30M	S30 ø0.15"	S30 ø0.20"	S35 ø0.15"	S35 ø0.20"	S35W
<b>Splice Parts</b>								
S90	●	●	●	●	●	●	●	●
S14		A,B	A	A,B		A,B		
S14M	A,B							
S330					A,B		A,B	A,B
S40	●							
S150		●	●	●	●	●	●	●
S40B	●	●	●	●	●	●	●	●
S41B		●	●	●	●	●	●	●
S90H	●	●	●	●	●	●	●	●
<b>Weld-Mount</b>								
S51	A							
S52		A	A,B	A,B	A,B	A	A	A
S60	D							
S63		D	D	D	D	D	D	D
<b>Screw-Mount</b>								
S46	A							
S47		A						
S56	D							
S57		D						
S153				D	D	D	D	D
S154			D					
S155	D							
S145						B	B	B
S145M			A	A,B	A,B	A	A	A
S146	A		B					
S45M		A,D	A,B,D	A,B,C,D	A,B,C,D	A,D	A,D	A,D
S45		A,D	B,D	A,B,C,D	A,B,C,D	A,B,C,D	A,B,C,D	A,B,C,D
S80		A	A	A	A	A	A	A
S81		A	A	A	A	A	A	A
S87	●	●	●	●	●	●	●	●
S65		●	●	●	●	●	●	●
S66								●
S71/S72/S73	●	●	●	●	●	●	●	●